

the **e** senses

e-Sense **Customised Stand-alone**

FAGERHULT

Contents

e-Sense Customised Stand-alone sensors – basic functions	3
Installation	4
Mechanical cut-off, functions	4
Preset functions.....	6
Choice of sensor technology.....	7
Programming with remote control	8
Programming for personal settings	9–10
Reduced power, Standby dimming level.....	11
Delay times, Standby time	12
On/Off, Auto Mode	13
Lux Threshold	14
Shift button, Test function, Manual switch-on.....	15
Daylight control	16
Dual sensor technology	17–18
Wiring examples	19–21
Technical specification	22

e-Sense Customised Stand-alone sensors – 86370 and 86371

86370 and 86371 are sensors for individual installation in ceilings. 86370 is most suitable for surfaces with a ceiling height of max. 6 metres, while 86371 can detect higher heights up to 12 metres. 86371 also has two lenses for the best detection with the PIR sensor.

The sensor has a range of settings in order to optimise all functions:

- Choice of detection PIR or Microwave sensor, or a combination of these.
- Integrated power supply for connecting 20 DALI loads.
- Sync where several sensors can work together e.g. in a corridor.
- Pushbutton connection for manual control of light level.
- Daylight sensor for adjustment according to incident daylight.
- Lux threshold prevents the light from switching on when the lighting conditions have already been met.
- Choice of 16 different fixed function combinations on the sensor.
- Choice of sensor technology on the sensor.
- Programming with remote control 86368.
- Quick programming of all function selections with 86368.
- Installation in ceiling panel (A-socket) or surface mounted in the accompanying socket.
- Lens for limiting the PIR detection range.
- Setting the sensitivity of the microwave sensor's detection range.
- For installation with socket in the ceiling panel use accessory 86393.

Installation

Sensor can be placed on a suitable base or surface mounted or recessed. When using the microwave sensor, a stable base is important.

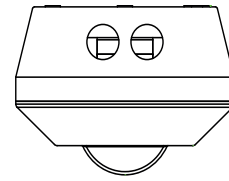

The sensor is supplied with an installation socket for surface mounted installation. Four lead-in throughs.

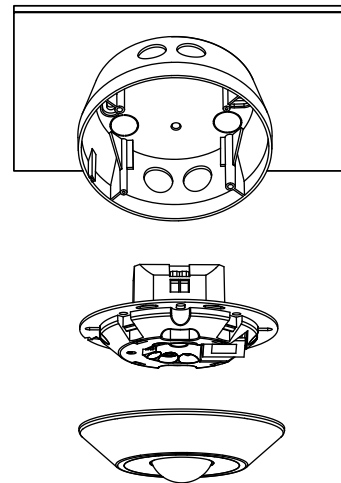

If you remove the socket, the sensor can be installed recessed in standard A-socket for 60 mm holes.

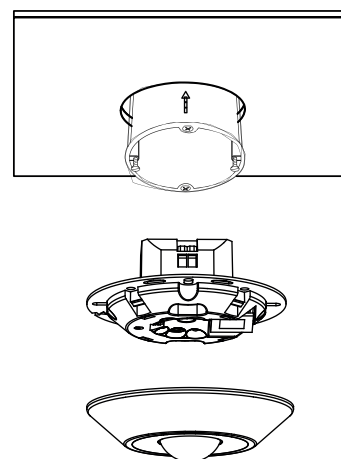

Mechanical cut-off

The sensor is also supplied with mechanical cut-off which can limit the detection range. NOTE! Only if you use the PIR sensor.

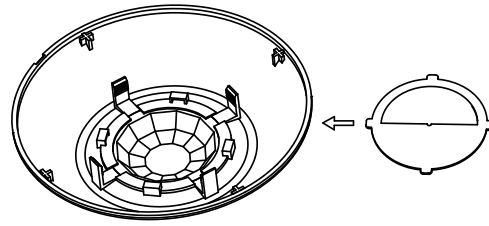

Functions

e-Sense Stand-alone is a flexible sensor that has several options to optimise the function.

- PIR sensor for detecting reflected heat (people).
- Microwave sensor that detects movement even through walls and glass.
- Light sensor for setting the lux threshold and/or daylight level.
- IR receiver for programming with remote control.
- Mode switch for selection of sensor technology
- Rotary switch for setting the finished functions according to the table.

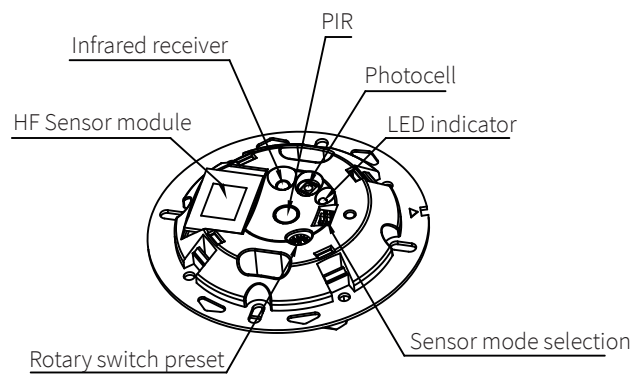

Preset functions

The rotary switch on the sensor is for selecting a finished package with presets. The functions are according to the table below. The functions can always be changed in detail with remote control 86368. If you then use the rotary switch again, it is that setting that applies. The sensor is supplied with setting mode 0 which 5 min after the last presence is detected adjusts to 10%, and 5 min until it switches off.

Settings rotary switch on 86370 and 86371

Selection of preset 1-F	Detection	Delay time	Standby time	Standby dimming level	Daylight Threshold
0	100 %	5 min	5 min	10 %	Disabled
1	100 %	5 sec	10 s	10 %	Disabled
2	100 %	5 min	10 min	10 %	Disabled
3	100 %	5 min	+ ∞	10 %	Disabled
4	100 %	5 min	+ ∞	10 %	Disabled
5	100 %	5 min	+ ∞	30 %	Disabled
6	100 %	10 min	30 min	10 %	Disabled
7	100 %	10 min	+ ∞	10 %	LOW
8	100 %	10 min	+ ∞	10 %	LOW
9	100 %	10 min	+ ∞	30 %	MID
A	100 %	20 min	1 h	10 %	Disabled
B	100 %	20 min	+ ∞	30 %	MID
C	100 %	30 min	+ ∞	10 %	Disabled
D	100 %	30 min	+ ∞	30 %	MID
E	100 %	30 min	+ ∞	50 %	HIGH
F	100 %	5 sec	10 s	10 %	HIGH

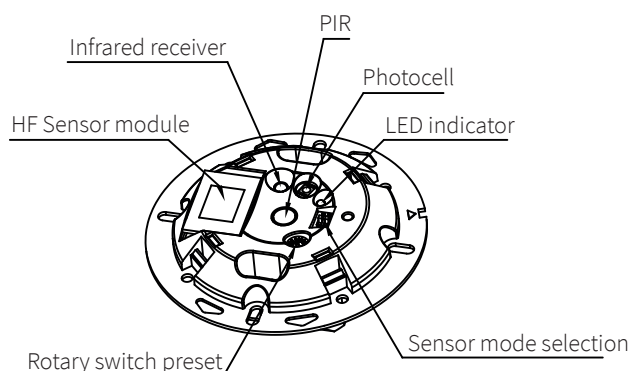

Choice of sensor technology

Sensors 86370 and 86371 have the option to select two different technologies to detect presence. The microwave sensor does not generally just detect movement from people and it can detect through walls and glass. The PIR sensor only detects infrared heat radiation (human heat) in motion. Choosing one of the sensor technologies or a combination of the sensors provide great opportunities to easily optimise control functions.

Using the red mode switch on the sensor, you can select the sensor technology function – PIR sensor or Microwave sensor. It is also possible to perform two combinations of both technologies. If you use the remote control, you can use it to change the settings.

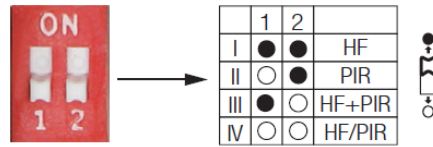

- I Both of the switches in the ON position:
Microwave sensor
- II Switch 2 in ON position: Only PIR sensor
- III Switch 1 in ON position: Microwave sensor + PIR sensor (both of the sensors must detect in order for the light to switch on).
- IV Both of the switches in the OFF position: Microwave sensor/PIR sensor (either of the sensors switches the light on).

Programming with remote control 86368

Simple programming functions

Sensors 86370 and 86371 can be programmed remotely using a remote control without needing to set any function in the sensor. This makes it easy to perform quick changes in all functions.

The following pages describe the different procedures to complete an installation.

Certain functions on the remote control have no function in this system, and cannot affect the end result of the programming.

A difference between 86370 and 86371 is that 86371 indicates with a flashing light source when a signal is received from the remote control. This is due to installation at a high height. 86370 has an integrated red LED that indicates the same thing.

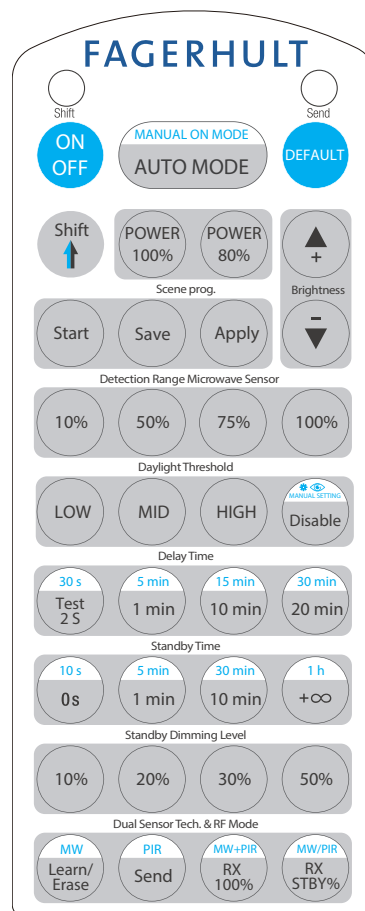

Default setting of the sensor

On delivery, the sensor has a standard setting that is also very easy to use as start for the installation. The default settings are:

Delay time: 5 min.

Standby time: 5 min.

Standby dimming level: 10%

Daylight Threshold: Disabled

Sensor active: PIR and Microwave

Manual on mode: Deactivated (presence detection)

Regardless of which settings are made, it is always easy to reset the presets using the DEFAULT button.

On delivery the rotary switch on the sensor is set to 0 which gives the settings above. If the switch is changed to another position, that will be the standard setting.

By pressing the DEFAULT button the sensor also adjust the fade-time of the connected drivers. On some drivers the standard fade-time might make the light look flickering whilst dimming up or down. By pressing the DEAFULT button the fade-time is increased making the dimming smoother.



Pre-set Scenes

It is possible to download all settings in the remote before transmitting the package to a sensor. Go through the steps as described below.

The settings that can be part of a package is:

Detection range (micro wave Sensor only)

Daylight Threshold

Delay time (after last movement detected)

Standby Time (time at dimmed low level)

Standby dimming level (Low level before OFF)

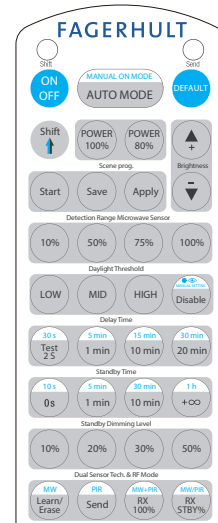

Press Start.



Select Detection Range (If Microwave sensor is used).

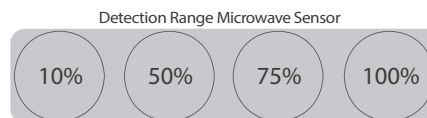

Select Daylight Threshold or Disable the function

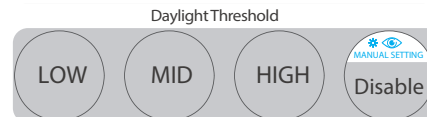

Select Delay Time (use Shift Button to alternate to BLUE functions).

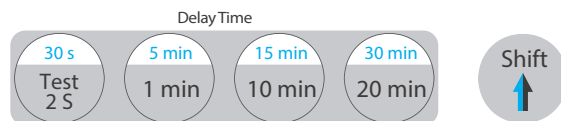

Select Standby Time (use Shift Button to alternate to Blue functions).

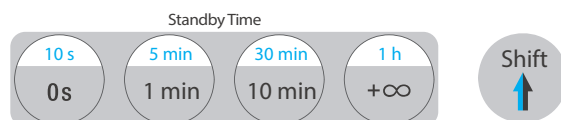

Select Standby Dimming Level.



Memory for saving settings. And use Apply to sensing information to sensor (The luminaire will blink to confirm the received information.).

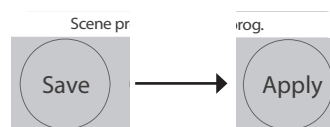

Programming of personal settings

Delay Time

Time after last presence detected. After time has elapsed, light will dim to Standby Dimming level.

Standby Time

How long light will remain on low level before turning off. The off function can be avoided by selecting $+\infty$ (infinity button).

Standby Dimming Level

How bright the light will be during the Standby Period. 10, 20, 30 or 50 % light level can be selected.

Daylight Threshold

If daylight is brighter than the set value, light will not turn on when presence is detected.

Detection Range for Microwave Sensor

Depending on height and setting, the detection range can be seen on pages 17–18. PIR sensor can be restricted by covering part of the lens.

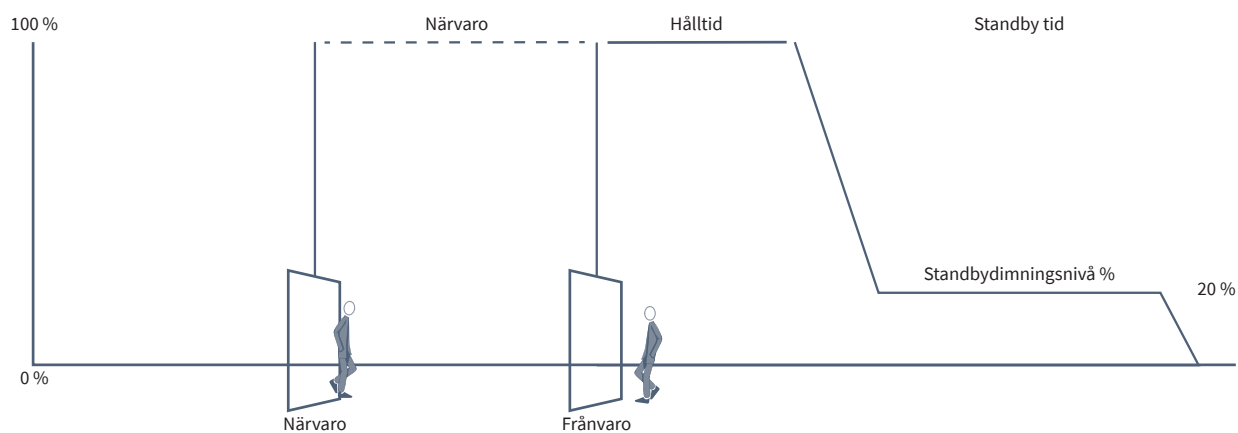

Reduced power

Default and normal use will give full light output 100 % at presence. But it is possible to reduce power by 20 %. This can be useful during a light fixtures first years of use, where the light output can be more than the estimated value. Return to 100 % by pressing Power 100 % button. This has to be made manually, no clock or calendar function is used.

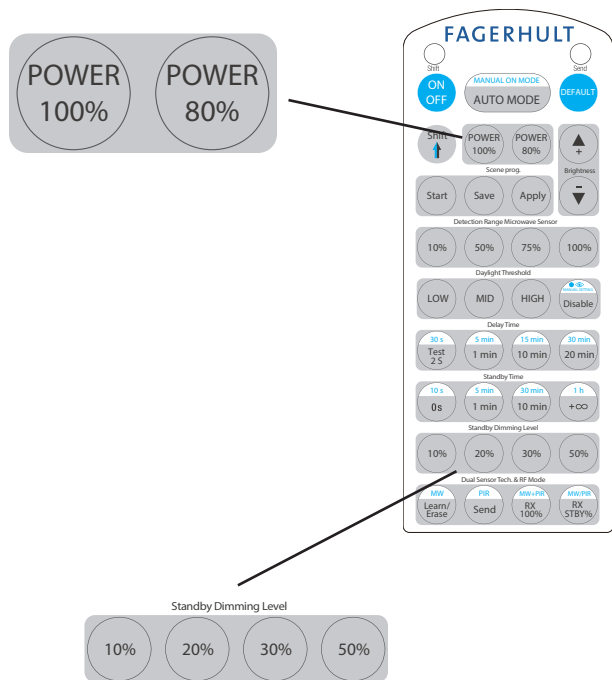

Standby dimming level

Standby Dimming Level is setting the light output during Standby Time. This means that light can be set to a functional level during absence, with enough light for the surrounding area. More light can be used close to exists, stairwells, lifts etc.

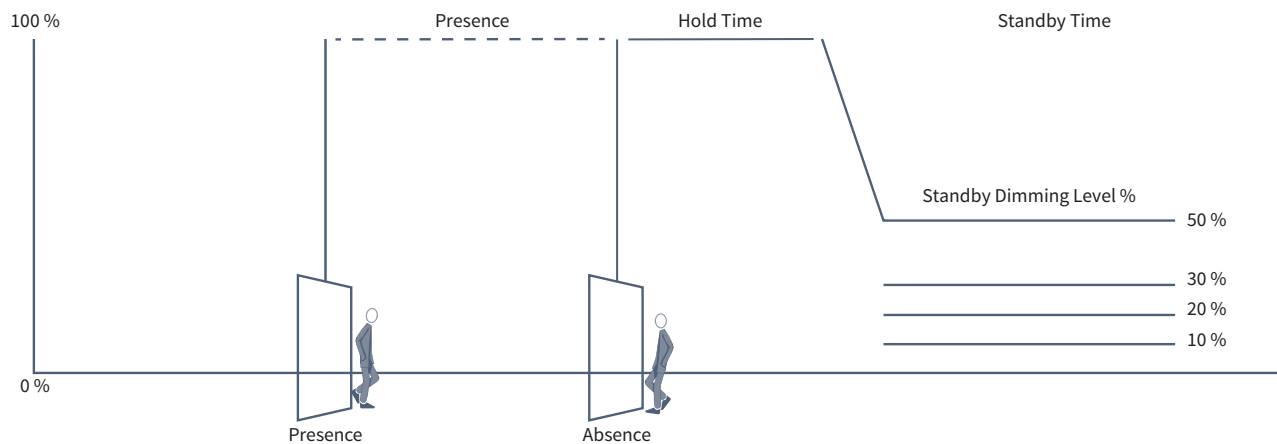

Delay Time

Delay Time sets the time period that light should remain on 100 % after last presence detection. Depending on the light source, and location, the time can be set to very short (LED's) or longer for fluorescent tubes. A longer time can be used to avoid rapid on/off sequences, which can be irritating. Select values in blue by pressing the Shift button first. The TEST function is explained later in this document.

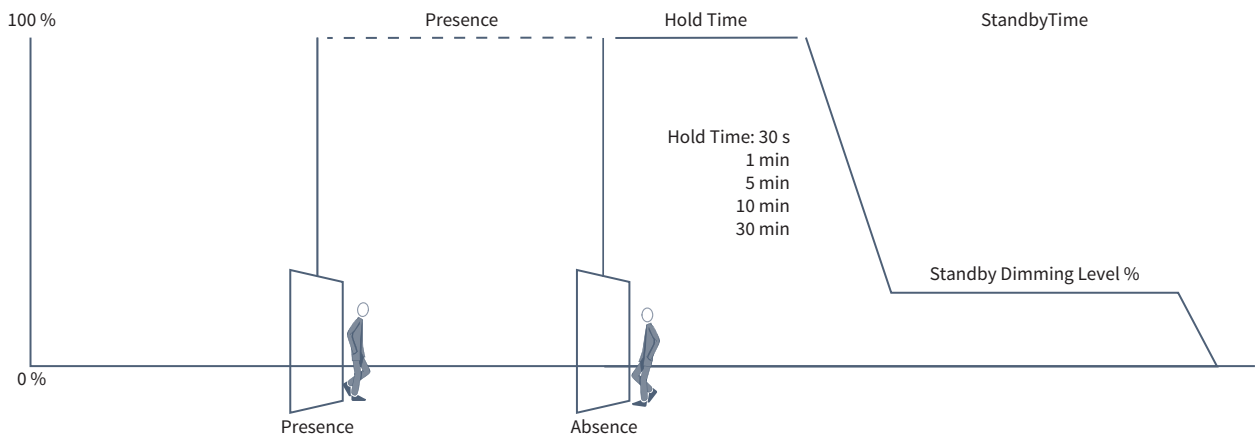
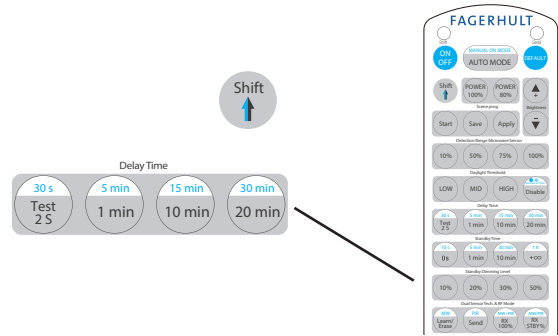

Standby time

Standby time sets the time for how long light should remain ON at Standby Dimming Level. After Delay Time, light can go directly to OFF (0 s), 10 s, 1 min, 5 min, 10 min, 30 min, or remain ON without turning OFF at all +∞ (infinity button). Select values in blue by pressing the Shift button first.

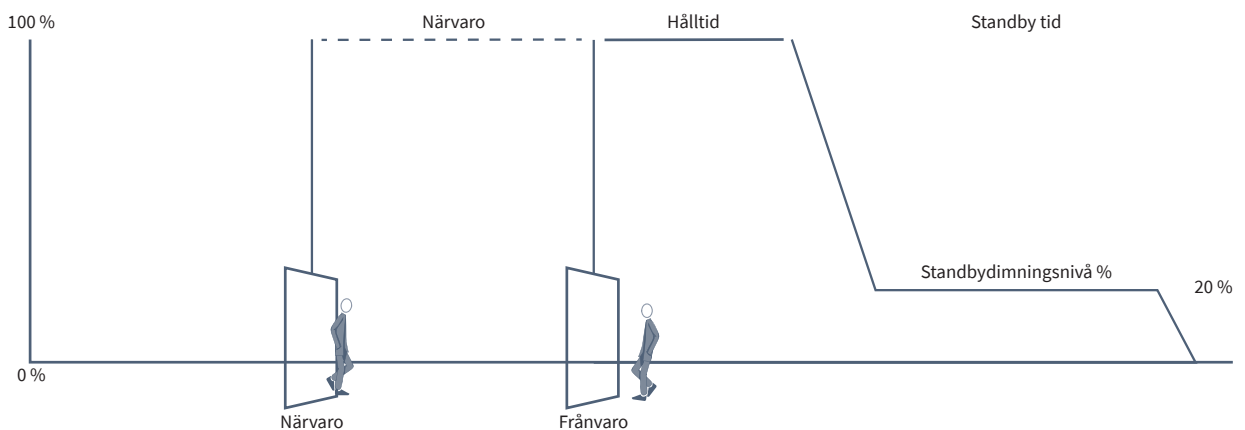
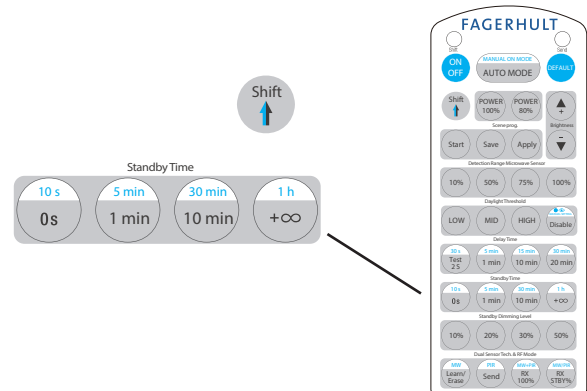

ON/OFF Function Constant ON

Press once, and light will remain ON until other action is taken. This will leave light constantly ON at 100 %. Presence is muted. To leave this mode, press Auto Mode or DEFAULT button. Auto Mode will make the setting go back to previous programming. DEFAULT will return all settings to default.

NOTE: A power failure will remove this function to previous setting (Auto Mode).

ON
OFF

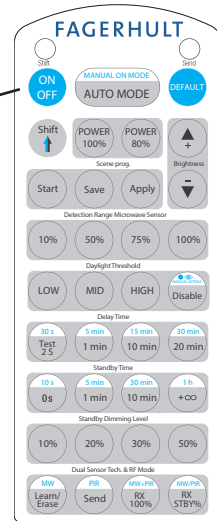

ON/OFF Function Constant OFF

Press once more, and light will remain OFF until other action is taken. This will leave light constantly in OFF position. Presence is muted. To leave this mode, press Auto Mode or DEFAULT button. Auto Mode will make the setting go back to previous programming. DEFAULT will return all settings to default.

NOTE: A power failure will remove this function to previous setting (Auto Mode)

ON
OFF

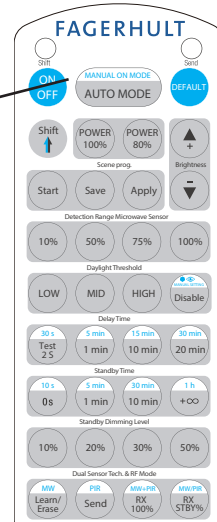

Auto Mode

Press this button once to leave any state of the ON/OFF function. This will return the sensor to previous settings.

MANUAL ON MODE
AUTO MODE

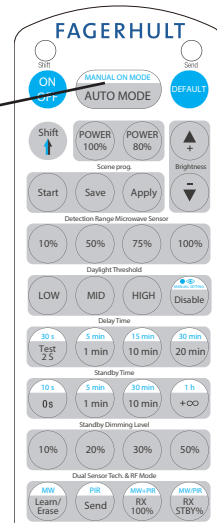

Lux Threshold

A Lux Threshold will save energy when there is no need for artificial light. The Lux sensor is reading through the fixture cover when light is off. If the set value of lux is already fulfilled with daylight, the presence detection is muted, and light will remain off. The RF-signal will still be sent out to other sensor that might be under their individual Lux Threshold setting. This will make the system very flexible. The detection of presence can be muted if there is already sufficient amount of daylight in the area. The settings are Manual, Low, Mid, High and Lux Disable.

Manual Setting of Lux Threshold

This setting must be done on site at the actual moment when light should mute the sensor.

Low Lux Threshold

With this level activated, the presence detection of the sensor will only work if the surrounding light level is more or less completely dark. Any light will mute the sensor.

Medium Lux Threshold

With this level activated, the presence detection of the sensor will be muted during daytime. For a more exact dusk or dawn setting, use the manual setting

High Lux Threshold

With this level activated, the presence detection of the sensor will be muted during full effect of daylight. For a more exact dusk or dawn setting, use the manual setting.

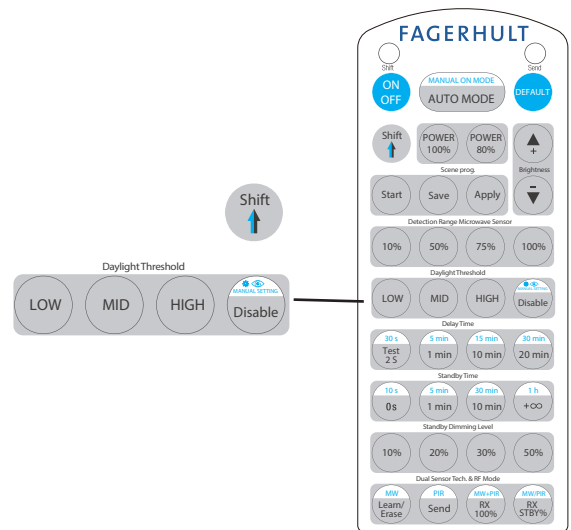

Manual learning Sequence

Press the “eye” button (press Shift button first). The sequence will start by turning the light off. During this period, the lux sensor will read and memorize the light level. This will then be used as a threshold for when the sensor shall act or be muted when detecting presence. More light than the set level; light will not turn ON. Less light, light will turn ON.

Lux Disable

This setting lets the sensor work without any effect of surrounding daylight. The light will always turn on when presence is detected.



If surrounding light is HIGHER than the threshold setting. Presence will not turn lights on.

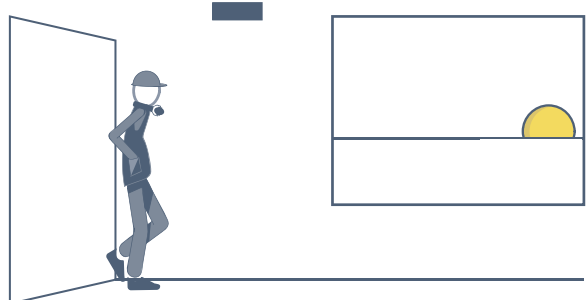

If surrounding light is LOWER than the threshold setting. Presence will turn lights on.

Shift button

The Shift Button will activate all functions in blue. When the shift function is active, the selected value can be sent directly to a sensor, or part of the Save/Apply procedure. The Shift function is active for 20 seconds after last selected value is pressed. The the remote will return back to normal status.

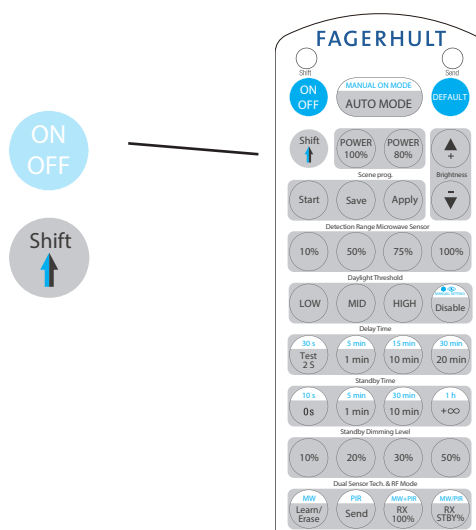

Test function

The TEST function is used for checking the sensors detection range. All other functions are temporarily muted. Light will dim down after 2 s. of absence, and go to 100% when presence is detected. For return to normal mode, select Auto Mode button or Default button.

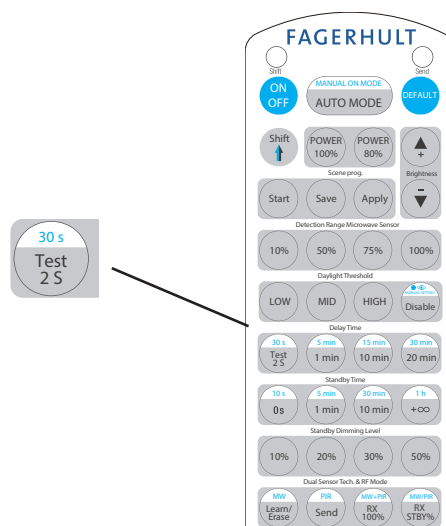

Manual switch-on

You can prevent the sensor switching on automatically in the event of movement, so called manual switch-on (the sensor will switch off as normal), which is common in classrooms. This requires that you have an impulse pushbutton installed on the sensor, see the wiring diagram.

Press Manual On Mode to activate the function. An impulse pushbutton also gives the option to manually adjust the light level temporarily.

Deactivate Manual on mode by pressing the DEFAULT button. This will also convert other settings back to the default operating mode, see page 8.

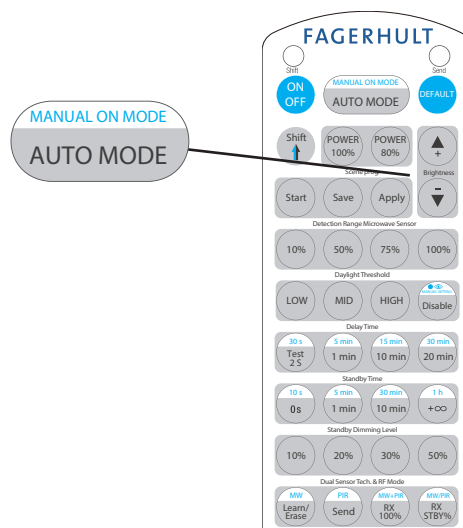

Daylight control

The sensor has an integrated lux sensor which can be used to use less light when there is sufficient incident daylight.

The setting should be made with as little daylight as possible. Using a lux meter is also useful for finding the right value. Remember that the lux sensor is located below the PIR lens and therefore measures a summarised value.

Adjust the light using the Brightness buttons to the desired level and the setting is saved. You can change this at any time. If you want to remove the function, press the Disable button (any lux threshold will also be removed).

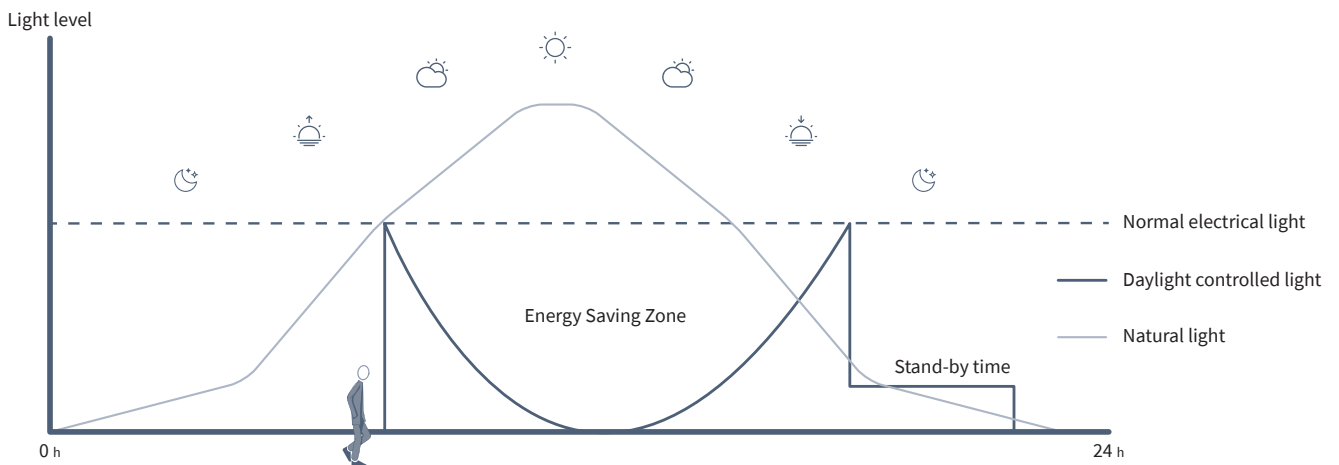
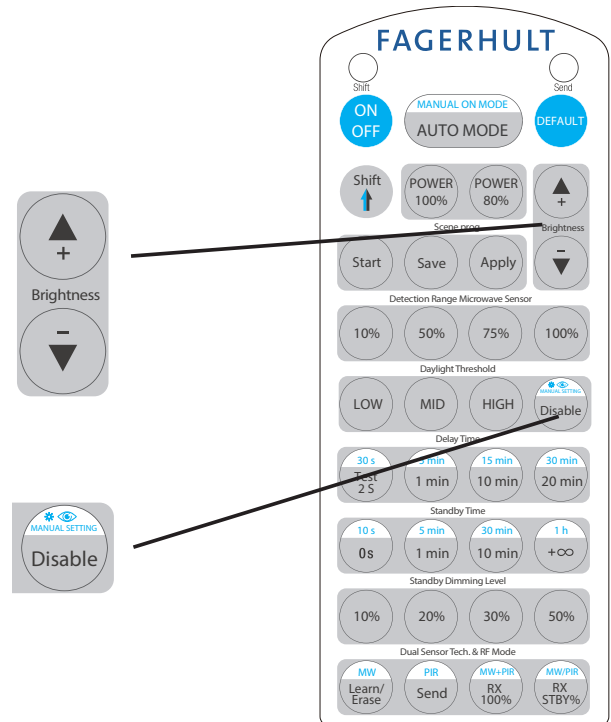

The integrated daylight sensor measures the incident light and calculates how much electrical light is required for the desired lux level. The sensor communicates with the drive unit via DALI to provide the correct amount of light.

Dual Sensor Technology

Detection takes place in two different patterns via the PIR sensor's two lenses. The PIR sensor cannot be set for larger detection areas, but it is possible to limit the range by covering part of the lens.

The microwave sensor works in a different way. The detection range can be changed here by reducing the output power. The output power can be set at 100%, 75%, 50% and 10%. At an installation height of 12 metres, the sensor will not work with the 10% setting. The dome-shaped detection area will simply be too small.

The sensors can be used one at a time or in combination.

PIR+MW: The light is on when both of the sensors are activated

PIR/MW: The light is on when PIR or MW is activated

PIR: Only PIR

MW: Only microwave. The range can be adjusted.

Press the Shift button first, then select the sensor function that that will be in use. After a sensor is selected, it can take up 30 sec for it to "warm up" and operate normally.

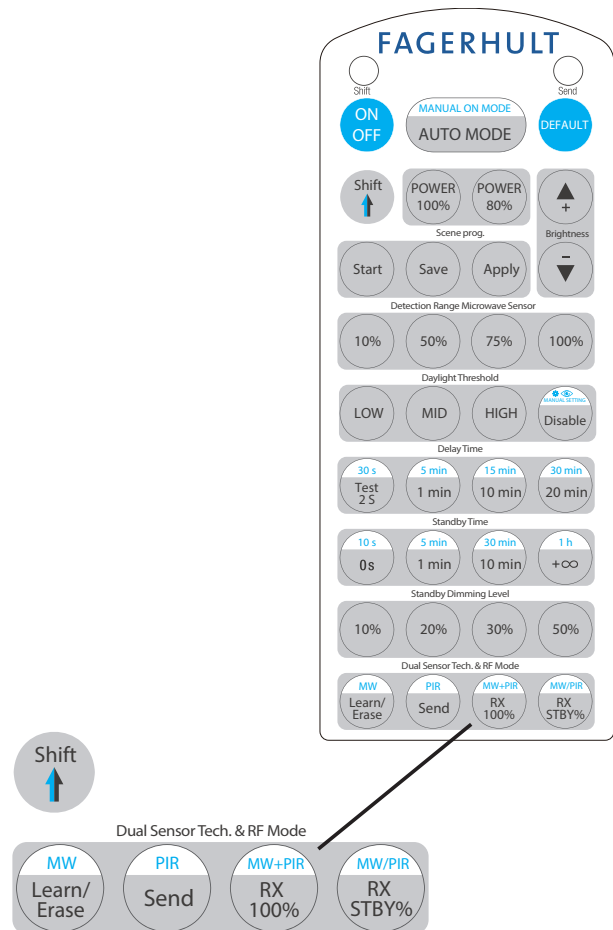

86370 Microwave and PIR sensor in combination (max 6 m)

The diagram shows the two sensors' various detection ranges at a ceiling height of 3 metres. 86370 will be used at a max. ceiling height of 6 metres. For a higher installation height, use 86371.

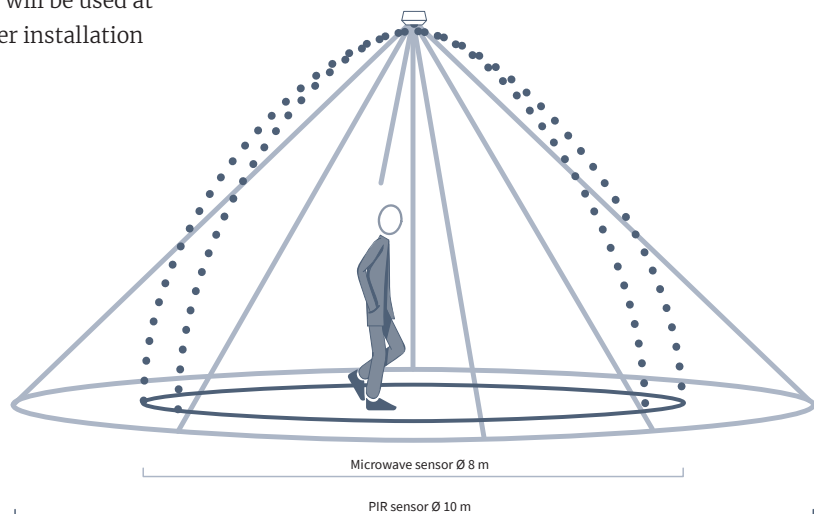

86371 Microwave and PIR sensor in combination (max 12 m)

The diagram shows the two sensors' various detection ranges at a ceiling height of 12 metres.

86371 is also supplied with a replaceable lens that is suitable for storage aisles and corridors with high ceilings. NOTE!

Only affects the PIR sensor's detection.

Rectangular lens is included in the packaging.

86371 with spherical lens

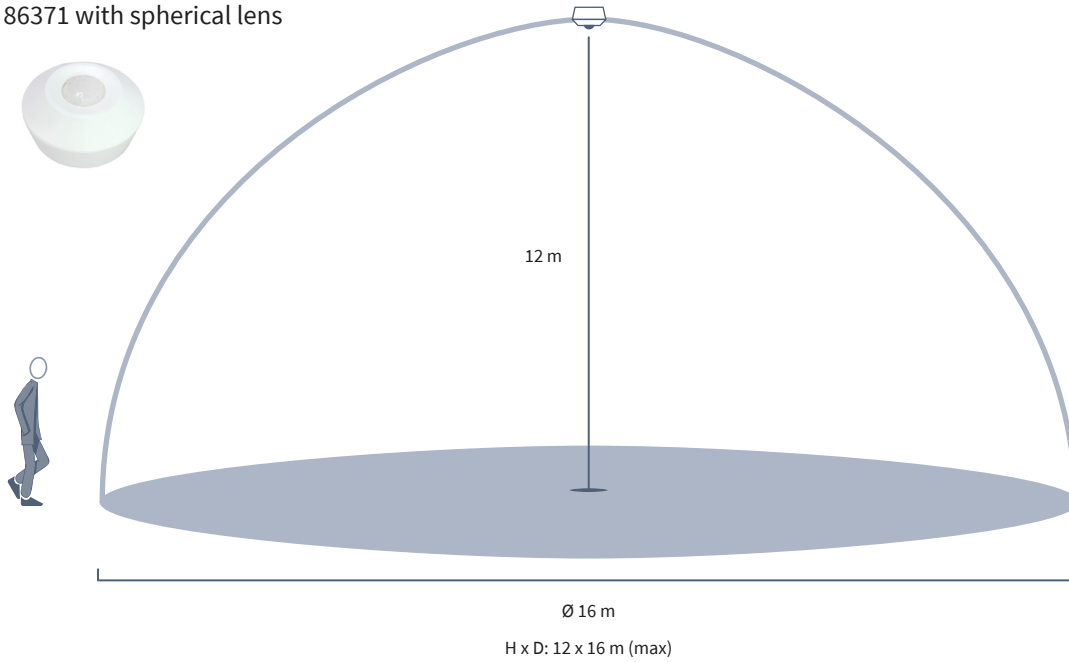

86371 with rectangular lens

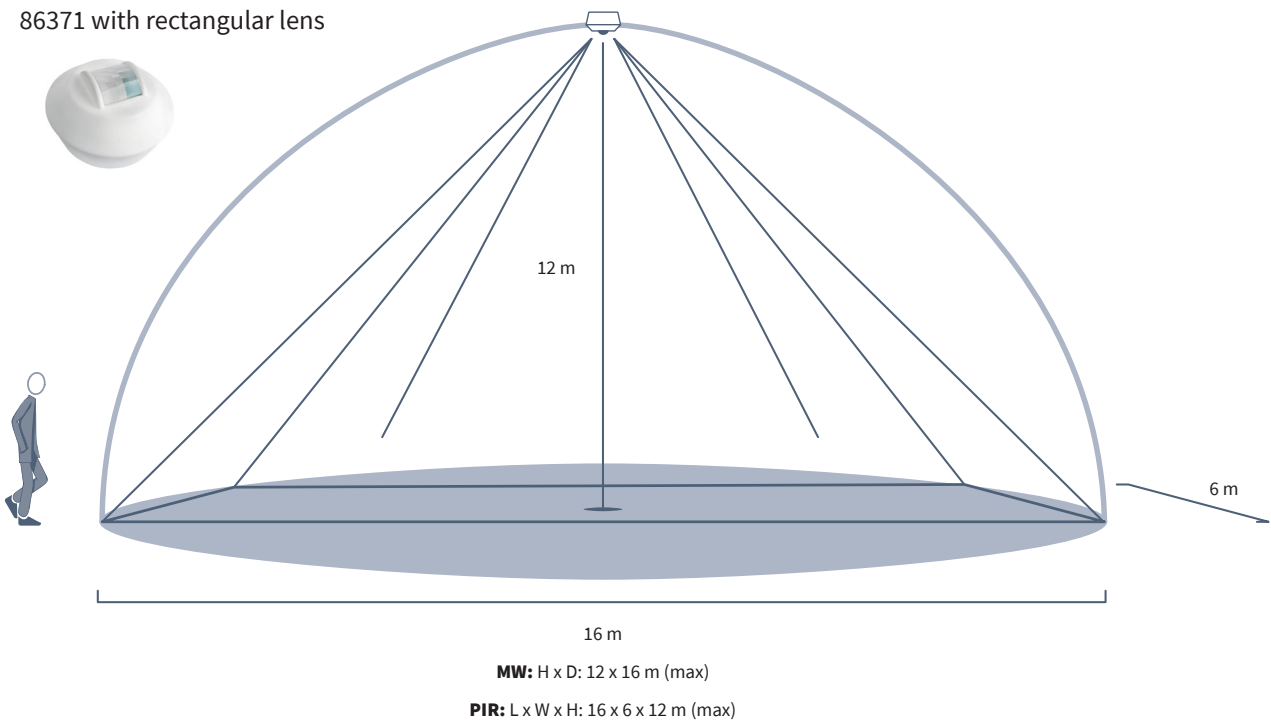

Wiring example 1

One sensor

Standalone with DALI Broadcast communication.

86370 or 86371 work as a standalone device that communicates with DALI.

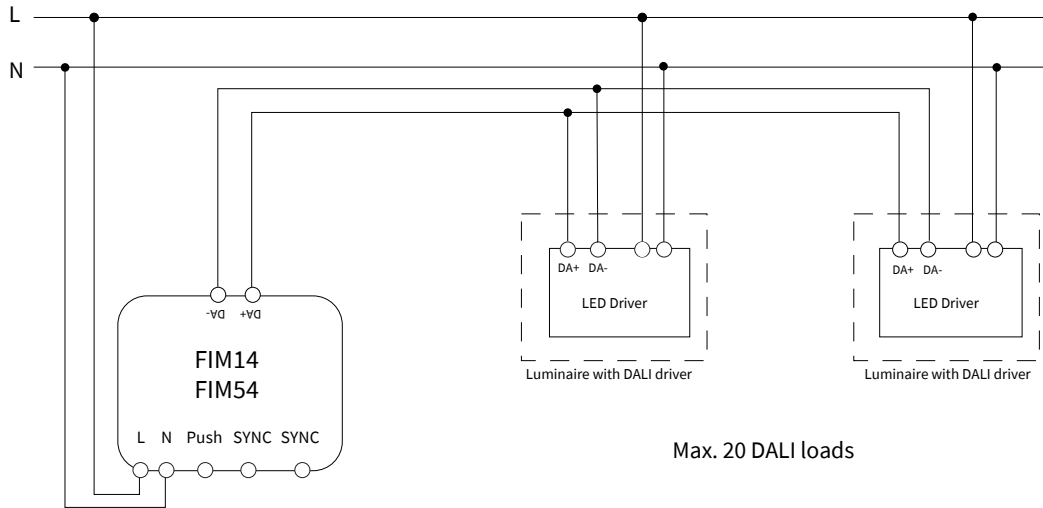

Wiring example 2

Two sensors, where one is connected to the control system

86370 or 86371 with sync function connected between sensors for a larger detection range. In the example, the DALI load is connected to a sensor but DALI loads can be connected to several sensors. A total of 5 sensors can be synchronised.

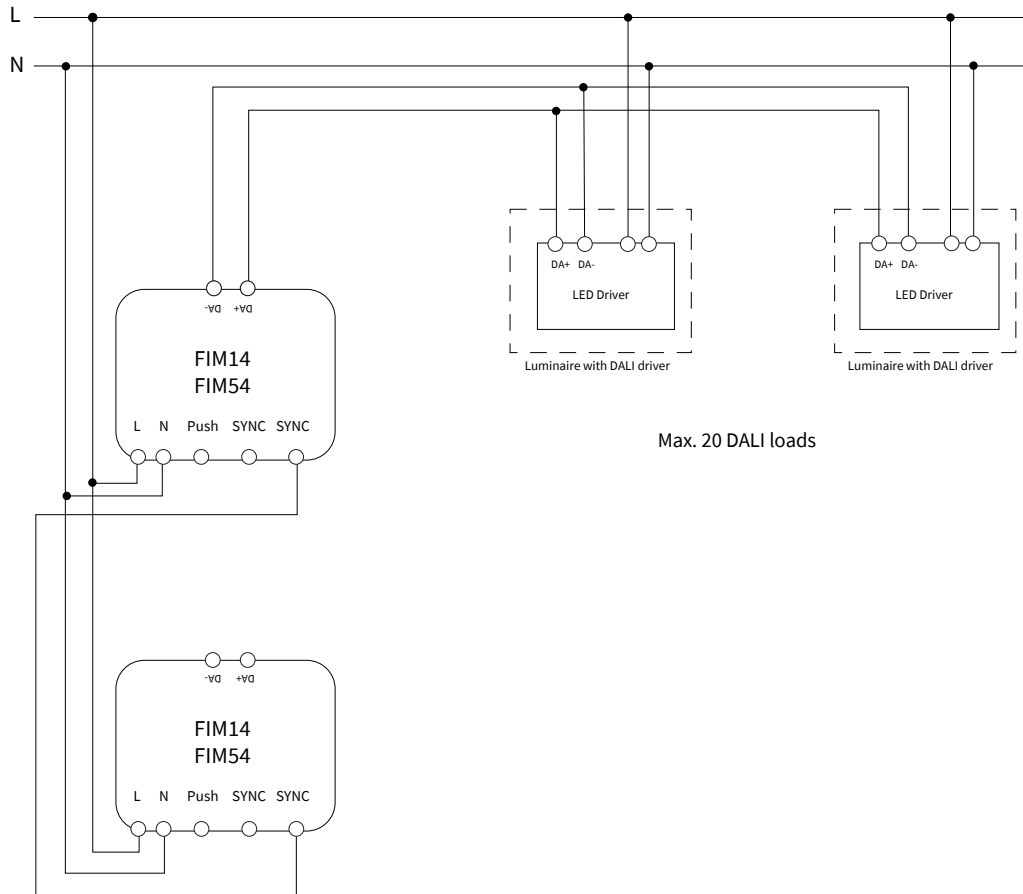

Wiring example 3

Two sensors, where one is connected to the control system and one manual pushbutton

86370 or 86371 with sync function connected between sensors for a larger detection range. In the example, the DALI load is connected to a sensor but DALI loads can be connected to several sensors. A total of 5 sensors can be synchronised. A momentary pushbutton is connected to the sensors for manual dimming.

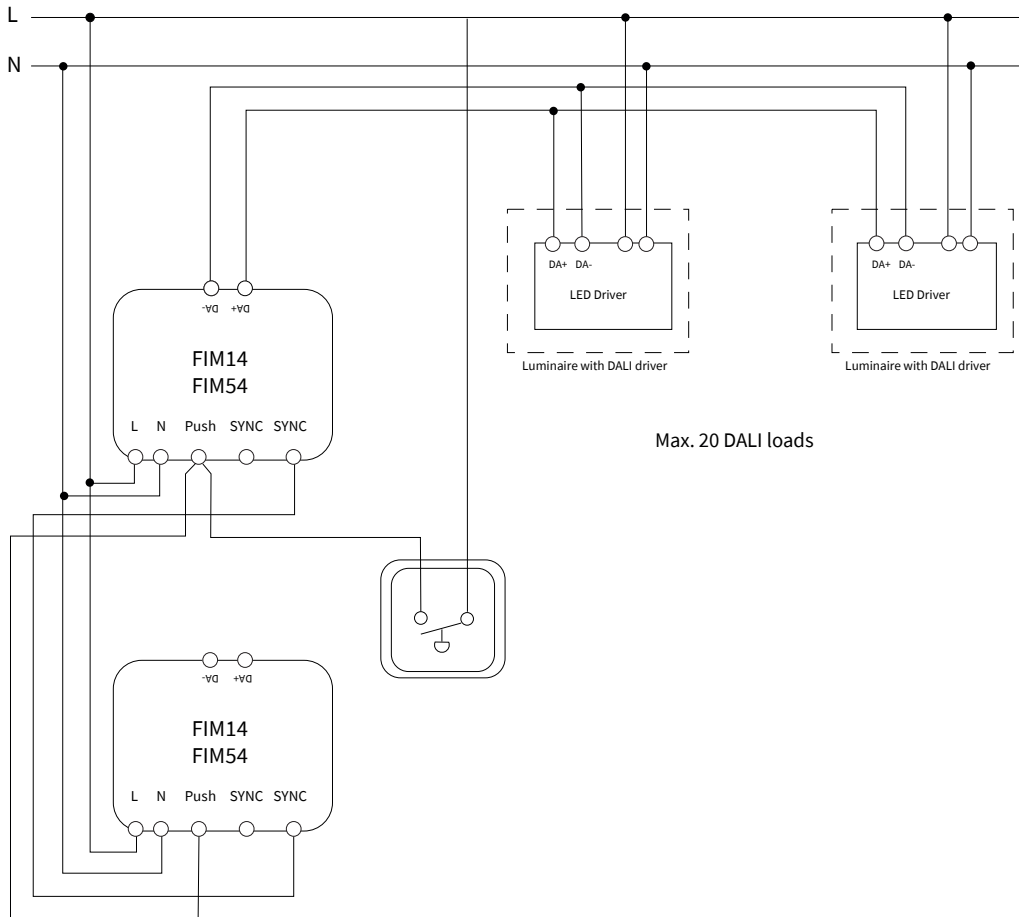

Technical specification

Product	86370 and 86371
Supply voltage	120 - 227 VAC 50/60Hz
DALI power supply	40 mA, max 20 loads
Power consumption	< 1 W
Detection range	360°
Detection area(DxH) 86370	12 m x 6 m (maximum)
Detection area (DxH) 86371	16 m x 12 m (maximum) with spherical lens
Detection area (DxWxH) 86371	16 m x 6 m x 12 m (maximum) with quadratic “corridor” lens

e-Sense **Customised Stand-alone**

Fagerhult develops, manufactures and markets professional lighting systems for public environments. Our operations are run with a constant focus on design, function, flexibility and energy saving solutions.

Fagerhult is part of the Fagerhult Group, one of Europe's leading lighting groups with operations in more than 15 different countries. AB Fagerhult is listed on the NASDAQ OMX Nordic Exchange in Stockholm.

HEAD OFFICE SWEDEN
Fagerhults Belysning AB
SE-566 80 Habo, Sweden
Tel +46 36 10 85 00
Fax +46 36 10 86 99
www.fagerhult.se